



Skill Development Industrial Diploma in Distance Learning

ISO
9001:2015
Certified

A GATEWAY TO ENTER INTO CORPORATE WORLD

Its time to prove yourself

Skill Development | Self Learning Study Material | Globally Accepted | Autonomous

One who Effectively Organizes All Rounds of this Event will be declared as



Guidelines :

- Paint Coating Technology
- Automotive Paints
- Quality Control & Assurance
- Material Management
- Ink Printing Technology

- Paper Pulp
- Cheminformatic
- Mechanical Science
- Welding Fabrication
- Chemical Science



Cheminformatic Institute of Science Studies Lucknow

(Undertaking "Shivi Professional Academy opc P. Ltd.)
Regd by Government of India, Ministry of Corporate Affairs

SF-5, LDA Commercial Complex, Vibhav Khand- 4, Gomti Nagar, Lucknow-226010 (UP) INDIA

ITI 05223590661 | M | +91 9554 064 000 , +91 9559 196 700

About Institute

Cheminformatic Institute of Science Studies Lucknow for Distance Learning is one of the largest autonomous distances learning education institute in India. Cheminformatic Institute of Science Studies Lucknow for Distance Learning (CIS) has, since its inception in 2011, made rapid strides in providing quality education to many students - making it one of the few large and most sought after distance learning institutes of India. Cheminformatic Institute of Science Studies Lucknow for Distance Learning (CIS offers PG Diploma, Diploma, Industry Diploma and Certificate programs across industry sectors including Paint Coating, Quality Control, Material Management, Petrochemical Refining, Paper Pulp, Chemical Science, Mechanical Engineering, Welding Fabrication and Automotive Paints, Paint Manufacturing etc. In addition, Our team partners with local, national, and international Professionals to offer the skill enhancement training. Leading organizations including Mahindra & Mahindra, Saboo Coating, Asian Paints, Uflex Ltd, Toyo Ink, Rajat Paints, Eicher, Sonalika, Maharani paints, Nerolac, Berger, Hero, Munjal Auto, AG Industries etc . are amongst others who have collaborated with CIS Studies Lucknow to offer the Training programs.

In order to ensure quality, CIS gets the best of academic resources for teaching, evaluation, e-Learning and self-learning material preparation from its sister Management Institutes as well as from the industry. The curriculum is comparable to that of any full time management institute. The curriculum is designed and constantly updated by the Academics Department comprising faculty from top ranks of the industry and having several years of teaching experience. CIS Studies Lucknow has full time and over adjunct faculty who are available for academic counseling, developing curriculum and assessments and for providing feedback to students on their academic progress.

CIS has pioneered several innovative concepts in distance education such as: Introduction of a "Blended Learning" methodology for all our programs, combining all the three forms of learning, namely, Published / Printed - Self-Learning Material / Books, Digital e-learning, and Faculty Interaction - Chat Sessions and Online Classroom Facility

Introduction of highly interactive e-Learning content as a supplementary learning methodology to improve the understanding of concepts through case studies and practical examples, thereby bridging the gap between the book and the classroom. Computer based assignment system to provide students the flexibility and convenience to submit assignments at any time and receive immediate results and feedback.

The Virtual Classroom facility with the Faculties has removed the distance barrier between the teacher and the taught. This facility provided by CIS is an additional student support service to interact with faculty members online and live. Students can ask questions, have peer interaction and even replay an archived lecture. Virtual Classroom sessions are conducted for all courses throughout the year. Online Faculty Chat Sessions allow students to interact with faculty by typing their questions and receiving immediate answers in an online environment

Modular Course System with Credit Banking Facility: Ability to take any Single Course and Bank and Accumulate credits for future transfer to other programs of CIS thus providing Flexible Pathways of Learning.

An 'e' communication center which handles all student queries promptly & effectively

CIS Studies has a powerful web portal, www.cisstudies.in providing facilities like - Computer based Assignment Submission, computer based examinations Booking, Message Board, Counseling, Campus-email ID with 10GB mailbox, ability to view Admission Status and Academic Status, etc.

CIS Studies Lucknow is an ISO Certified institution since last 5 years. In 2011, CIS Studies Lucknow for Distance Learning has been accredited with ISO 9001:2015 certification. This certificate was awarded to CIS Studies Lucknow for successful establishment of "Quality Management System" by OMI Quality Certification as a certifying body.

Why CIS

After attending a course, you are capable to apply practices and put the subject matter learned into action. In addition to this, we have all types of facilities, which are needed to render there Industrial Courses & career improvement solutions. Besides, we hold expertise in provide education & Training. We have career consultant who is having years of years experience in their domains Cheminformatics. We provide these courses that are probably amongst the best available in INDIA & Abroad for Industries Professional.

Our offered courses are experiential you learn from "professionals" by being guide to think about and experience the conditions to study.

Be all that you can be...

www.cisstudies.in

info@cisstudies.in

Welcome from the Chair of Institute



On behalf of the Cheminformatic
Institute of Science Studies Luck
Now extend a warm welcome.

We are a dedicated and active autonomous body, committed to making continued improvements at the Institute.

As well as fulfilling our duties by both supporting and challenging the senior leadership team to ensure that we have in place a clear strategic direction for the development of Cheminformatic Institute Of Science Studies Lucknow we also enjoy being involved in day to day events.

All staff, and parents/carers work together with a common aim of providing a safe and vibrant learning environment in which all professionals can reach their potential and have an enjoyable experience in this wonderful Institute.

Paint Coating Technology

PG Diploma in Paint Coating Technology (PGPCT)

Upon completion of this course, the participant will be able to:

Identify the types of paint and coatings to be used for various applications.
Understand the importance of surface preparation & the methods for achieving the same
Prepare various surfaces for painting as per internationally recognized standards.
Carry out paint application as per the given data sheets of paints, using airless spray-painting equipment.
Perform routine maintenance and repairs on Spray-painting and Grit-blasting equipment

Program Modules-

Module-I: Introduction & Principles To Paint Technology

Module-II: Powder Coating & Its Technology

Module-III: Nano Structured Coatings

Module-IV: Coatings for Corrosion Protection- Offshore Oil and Gas Operation

Module-V: Introduction to Paint Manufacturing

Module-VI: Emulsion Polymerization and Latex Applications

Module-VII: Coating Systems and Painting - the Application and Maintenance of Marine Coating Systems

Module-VIII: Wood Coated with Lead Based Paint

Eligibility;

The Eligibility for the PG program is Min. Graduation from any recognized university in any Discipline.

Course Fees Details

Duration	Course Fee		Prospectus Fees	
	In INR	In USD	In INR	In USD
12 months	14000/-	280 \$	700/-	35\$

Career Prospective

Senior Paint Technologist
Senior Coating Analyst
Production & Development Manager
QA & QC Inspector
Senior Supervisor
Paint & Coating Developer
Paint Shop Manager:



Be all that you can be...

Paint Coating Technology

Diploma Program in Paint Coating Technology (DPCT)

Upon completion of this course, the participant will be able to:

Identify the types of paint and coatings to be used for various applications.

Understand the importance of surface preparation & the methods for achieving the same

Prepare various surfaces for painting as per internationally recognized standards.

Carry out paint application as per the given data sheets of paints, using airless spray-painting equipment.

Perform routine maintenance and repairs on Spray-painting and Grit-blasting equipment

Program Modules-

Module-I: Introduction & Principles To Paint Technology

Module-II: Powder Coating & Its Technology

Module-III: Nano Structured Coatings

Module-IV: Coatings for Corrosion Protection- Offshore Oil and Gas Operation

Module-V: Introduction to Paint Manufacturing

Module-VI: Emulsion Polymerization and Latex Applications

Eligibility:

The Eligibility for this program is Min. 10th / ITI / 12th from any recognized board in any Discipline.

Course Fees Details:

Duration	Course Fee		Prospectus Fees	
	In INR	In USD	In INR	In USD
12 months	13000/-	260 \$	700/-	35\$

Career Prospective

Senior Paint Technologist
Senior Coating Analyst
Production & Development Manager
QA & QC Inspector
Senior Supervisor
Paint & Coating Developer
Paint Shop Manager
Chemist
Painter



Be all that you can be...

Paint Coating Technology

Advance Diploma in Paint Coating Technology (APPCT)

The shift to more environmentally complaint paint formulation is having an overall stimulate effect on demand for raw materials because these types of coatings tend to require higher loading of resins, pigments, fillers & additives and modifier than traditional solvent based formulation.

Program Modules-

Module-I: Introduction & Principles To Paint Technology

Module-II: Powder Coating & Its Technology

Module-III: Nano Structured Coatings

Module-IV: Coatings for Corrosion Protection- Offshore Oil and Gas Operation

Module-V: Introduction to Paint Manufacturing

Module-VI: Emulsion Polymerization and Latex Applications

Module-VII: Coating Systems and Painting - the Application and Maintenance of Marine Coating Systems

Module-VIII: Wood Coated with Lead Based Paint

Module IX: Industrial Painting & Coating

Eligibility:

The eligibility of the course is Diploma / ITI with Industrial Working Experience (Min. 1 years)

Course Fees Details

Duration	Course Fee		Prospectus Fees	
	In INR	In USD	In INR	In USD
12 months	15000/-	300 \$	700/-	35\$

Career Prospective

Senior Paint Technologist
Senior Coating Analyst
Production & Development Manager
QA & QC Inspector
Senior Supervisor
Paint & Coating Developer
Paint Shop Manager:



Paint Technology

Advance Diploma in Paint Manufacturing (ADPM)

The broad objectives are to phase out the manufacture and sale of paints containing lead and eventually to eliminate the risks from such paint. Specific objectives are:

(a) To raise the awareness of government authorities and regulators, private industry, manufacturers, consumers, workers, trade unions and health-care providers about the toxicity of lead in paints and the availability of technically superior and safer alternatives;

(b) To catalyse the design and implementation of appropriate prevention-based programmes to reduce and eliminate risks from the use of lead in paint. When processes for phasing-out lead are put in place in installations manufacturing paint, arrangements must be made to ensure a fair transition that protects workers' health and employment.

(c) To provide assistance to paint manufacturers that continue to produce and market paints containing lead to enable them to phase out lead from their paints;

Program Modules:-

Module-I: Introduction & Principles To Paint Technology

Module- II : Introduction to Paint Manufacturing

Module- III : Occupational Exposures Ln Paint Manufacture And Painting

Module- IV : Paint Manufacturing Hazardous Waste Listing Determination

Module- V : Manufacturing of Paint & Allied Coating Products

Module - VI: Control of VOC Emissions from Ink & Paint Manufacturing Process

Eligibility

This Program is designed for professionals, manufacturer having qualification minimum 10+2 standards from any Board . Information on the available coatings from some manufacturer in the country and abroad.

Course Fees Details

Duration	Course Fee		Prospectus Fees	
	In INR	In USD	In INR	In USD
12 months	14000/-	280 \$	700/-	35\$

Career Prospective

Senior Paint Technologist
Senior Coating Analyst
Production & Development Manager
QA & QC Inspector
Senior Supervisor
Paint & Coating Developer
Paint Shop Manager:



Paint Coating Technology

PG DIPLOMA IN PAINT & COATING TECHNOLOGY (PDPCT) – 2 Years

With millions of paint formulations available from various manufactures, and a lots of new and sophisticated techniques of Paint application & Surface preparation, Paint Coatings has become science & Art, and every person, wether he is a user, supervisor, applicators, supplier or manufacturer need a proper knowledge in order to get maximum life out of a particular Paint formulation.

Further, Paint testing has become necessary both at the pre- qualification stage , during the application and Even after the paint has been applied for periodic assessment of its life.

Program Modules-

Semester: I

- Module 1 Professional Communication
- Module 2 Introduction to Paint Technology
- Module 3 Resin Technology I
- Module 4 Additive and Emulsion
- Module 5 Architectural Coatings

Semester: III

- Module 11 Production and Operations Management
- Module 12 Protective Coating II
- Module 13 Quality Management
- Module 14 Industrial Coatings
- Module 15 Automotive Paints and Coatings

Eligibility

The Eligibility of this program is Min Graduation

Semester: II

- Module 6 Pigments, Solvents and additives
- Module 7 Resin Technology-II
- Module 8 Paint Technology-II
- Module 9 Application Techniques I
- Module 10 Protective Coatings I

Semester: IV

- Module 16 Coatings Formulation
- Module 17 Advance Paint Finishing Technology
- Module 18 Surface Chemistry & Engineering
- Module 19 Safety, Health and Environment
- Module 20 Emulsion, Polymerization & Latex Application

Course Fees Details:

Duration	Course Fee		Prospectus Fees	
	In INR	In USD	In INR	In USD
24 months	24000/-	480 \$	700/-	35\$

Career Prospective

- Senior Paint Technologist
- Senior Coating Analyst
- Production & Development Manager
- QA & QC Inspector
- Senior Supervisor
- Paint & Coating Developer
- Paint Shop Manager:



Be all that you can be...

Paint Coating Technology

Professional Diploma in Paint Coating Technology (PPCT)

Painting and coating Course from the CIS Studies Lucknow – Learning, examination and certification for Paint Shop Professionals in accordance with the Institute of CIS. Paint Shop Professionals require the relevant training and qualifications in order to carry out painting and Paint Shopp Professionals to international standards.

The CIS Studies Lucknow offers world-class painting and coating Program, examination and certification for Paint Shop professionals, in accordance with the Institute of CIS Studies Lucknow

Program Modules-

Semester: First (Fee: 6000)

Module 1: Paint Application

Module 2. Emulsion polymerization and latex applications

Module 3. Introduction to Basic Manufacturing Processes and Workshop Technology

Semester: Third (Fee: 6000)

Module 1: Paints, Coatings and Solvents

Module 2: Effect Of Inorganic Pigments

Module 3: Effect of Heat Treatment on Deformation and Corrosion Behavior of Stainless Steel

Semester: Second (Fee: 6000)

Module 1: Paints, Varnishes, Lacquers, Enamels, and Allied Products Manufacturing

Module 2: Surface technology organic coatings

Module 3: Varnish

Semester : Final (Fee: 6000)

Module 1: Body and Paint

Module 2: Powder Coating & its Technology

Module 3: Nano Coating Techniques

Eligibility

The Eligibility for this program is 10th/ TI/ Diploma/ 10+2/ Graduation

Course Fees Details

Duration

24 months

Course Fee

In INR
24000/-

In USD
480 \$

Prospectus Fees

In INR
700/-

In USD
35\$

Career Prospective

Senior Paint Technologist
Senior Coating Analyst
Production & Development Manager
QA & QC Inspector
Senior Supervisor
Paint & Coating Developer
Paint Shop Manager:



Be all that you can be...

Paint Coating Technology

Certified Industrial Diploma in Paint Application Technology (CPAT)

Painting and coating Course from the CIS Studies Lucknow – Learning, examination and certification for Paint Shop Professionals in accordance with the Institute of CIS. Paint Shop Professionals require the relevant training and qualifications in order to carry out painting and Paint Shopp Professionals to international standards.

The CIS Studies Lucknow offers world-class painting and coating Program, examination and certification for Paint Shop professionals, in accordance with the Institute of CIS Studies Lucknow

Program Modules-

Semester: First (Fee: 8500 INR)

CPAT1.1:- Professional Communication
CPAT1.2:- introduction to Paint Technology –I
CPAT1.3:- Resin Technology I
CPAT1.4:- Additive and Emulsion
CPAT1.5:- Architectural Coatings

Semester: Second (Fee: 8500 INR)

CPAT2.1:- Pigments, Solvents and additives
CPAT2.2:- Resin Technology-II
CPAT2.3:- Paint Technology-II
CPAT2.4:- Application Techniques I
CPAT2.5:- Protective Coatings I

Semester: Third (Fee: 8500 INR)

CPAT3.1 :- Production and Operations Management
CPAT3.2 :- Protective Coating II
CPAT3.3 :- Quality Management
CPAT3.4 :- Industrial Coatings
CPAT3.5:- Automotive Paints and Coatings

Semester : Final (Fee: 8500 INR)

CPAT4.1:- Coatings Formulation
CPAT4.2:- Advance Paint Finishing Technology
CPAT4.3:- Surface Chemistry & Engineering
CPAT4.4:- Safety, Health and Environment
CPAT4.5:- Emulsion, Polymerization & Latex Application

Eligibility

10th/ ITI/ Diploma/ 10+2/ Graduation

Course Fees Details

Duration	Course Fee		Prospectus Fees	
	In INR	In USD	In INR	In USD
24 months	32000/-	640 \$	700/-	35 \$

Career Prospective

Senior Paint Technologist
Senior Coating Analyst
Production & Development Manager
QA & QC Inspector
Senior Supervisor
Paint & Coating Developer
Paint Shop Manager:



Be all that you can be...

Www.cisstudies.in

info@cisstudies.in

Chemical Science

Diploma Program in Chemical Engineering (DPCE)

Chemical engineers use chemistry, biology, physics and math in an integrated engineering mode in order to manufacture materials and products to modern society. They are involved with the full scale of processes, from the laboratory bench to the pilot plant and eventually to the manufacturing facility. The academic training of chemical engineers provides a strong background for a variety of areas, including.

Program Modules-

Module I: Introduction to Chemical Engineering

Module II: Fundamentals of Chemistry

Module III: General Chemistry

Module IV: Chemical Engineering Thermodynamics

Module V: Organic Chemistry of Chemical Engineering

Module VI: Material Properties of Plastics

Eligibility

The eligibility for the Diploma program is 10th/ITI/Diploma holder/Working Professional in any discipline.

Course Fees Details

Duration	Course Fee		Prospectus Fees	
	In INR	In USD	In INR	In USD
12 months	12000/-	240 \$	700/-	35 \$

Career Prospective:

involved in the research, development and implementation of chemical processes



Be all that you can be...

Chemical Science

PG Diploma in Chemical Engineering (PGPCE)

A Chemical engineer may choose to work in a variety of industries which include chemicals, pharmaceuticals, food, energy, and environmental control. A chemical engineering degree also serves as a good preparation for law, business, or medical school.

Program Modules-

Module I: Introduction to Chemical Engineering

Module II: Fundamentals of Chemistry

Module III: General Chemistry

Module IV: Chemical Engineering Thermodynamics

Module V: Organic Chemistry of Chemical Engineering

Module VI: Material Properties of Plastics

Module VII: Techniques of Process Stimulation

Module VIII: Physical Chemistry of Chemical Engineering

Eligibility:

The eligibility for the PG program is Graduation in any Science discipline.

Course Fees Details

Duration	Course Fee		Prospectus Fees	
	In INR	In USD	In INR	In USD
12 months	14000/-	280 \$	700/-	35 \$

Career Prospective:

Involved in the research, development and implementation of chemical processes

Chemical Engineer

Lab Chemist



Be all that you can be...

Quality Control Management

Diploma Program in Quality Control & Quality Assurance (DPQC)

One way to ensure a quality product is to build quality into the process. Consider Steinway & Sons, the premier Maker of pianos used in concert halls all over the world. The tools in each of these categories provide different Types of information for use in analyzing quality. Descriptive statistics are used to describe certain quality Characteristics, such as the central tendency and variability of observed data.

Program Modules-

ModuleI: Basics of Quality

ModuleII: Statistical Quality Control

ModuleIII: Fundamentals of Quality Control and Improvement

ModuleIV: Quality management in mechanical

ModuleV: Quality Management Systems

ModuleVI: Contemporary Quality Concepts

Eligibility:

The eligibility for the Diploma program is ITI / Diploma holder and Working Professional in any discipline.

Course Fees Details

Duration	Course Fee		Prospectus Fees	
	In INR	In USD	In INR	In USD
12 months	12000/-	240 \$	700/-	35 \$

Career Prospective:

Quality assurance manager
Production & Development Manager
QA & QC Inspector
Senior Supervisor
Quality Engineer



Be all that you can be...

Quality Control Management

PG Diploma in Quality Control (PGQC)

One way to ensure a quality product is to build quality into the process. Consider Steinway & Sons, the premier maker of pianos used in concert halls all over the world. The tools in each of these categories provide different types of information for use in analyzing quality. Descriptive statistics are used to describe certain quality characteristics, such as the central tendency and variability of observed data.

Program Modules-

Module I: Basics of Quality

Module II: Statistical Quality Control

Module III: Fundamentals of Quality Control and Improvement

Module IV: Quality management in mechanical

Module V: Quality Management Systems

Module VI: Contemporary Quality Concepts

Module VII: Total Quality Management

Module VIII: Risk assessment and management

Eligibility

The eligibility for the PG program is Graduation in any discipline.

Course Fees Details

Duration	Course Fee		Prospectus Fees	
	In INR	In USD	In INR	In USD
12 months	14000/-	280 \$	700/-	35\$

Career Prospective:

Quality assurance manager
Production & Development Manager
QA & QC Inspector
Senior Supervisor
Quality Engineer



Be all that you can be...

Material Management

Diploma Program in Material Management (DPMM)

Material Management plays vital role in logistics and deals with scientific study of planning, organizing and control of flow of material from initial stage to final output. This is a specialized course designed for under standing need of material management in any organization for proper functioning. This degree program helps the students to understand the production activity in an integrated way and manage the flow of material and services.

Program Modules-

Module I: Operations Management

Module II: Inventory Management

Module III: Material & Store Management

Module IV: Legal Aspects of Supply Chain Management

Module V: Enterprise Resource Planning

Module VI: Just-in Time and Lean

Eligibility

The eligibility for the Diploma program is ITI/Diploma holder/Working Professional in any discipline.

Course Fees Details

Duration	Course Fee		Prospectus Fees	
	In INR	In USD	In INR	In USD
12 months	12000/-	240 \$	700/-	35\$

Career Prospective:

Store Manager
Store In-charge
Manager
Senior Supervisor



Material Management

PG Diploma in Material Management (PGMM)

Material Management plays vital role in logistics and deals with scientific study of planning, organizing and control of flow of material from initial stage to final output. This is a specialized course designed for understanding need of material management in any organization for proper functioning. This degree program helps the students to understand the production activity in an integrated way and manage the flow of material and services.

Program Modules-

Module I: Operations Management

Module II: Inventory Management

Module III: Material & Store Management

Module IV: Supply Chain Management

Module V: Concepts in Enterprise Resource Planning

Module VI: Just-in Time Manufacturing

Module VII: Purchasing Management

Module VIII: Introduction to E-Business Management & Strategy

Eligibility

The Eligibility for the PG program is Graduation in any discipline.

Course Fees Details

Duration	Course Fee		Prospectus Fees	
	In INR	In USD	In INR	In USD
12 months	14000/-	280 \$	700/-	35\$

Career Prospective:

Store Manager
Store In-charge
Manager
Senior Supervisor



Be all that you can be...

Mechanical Engineering

Advance Diploma in Mechanical Engineering (APME)

Mechanical engineering is a discipline of engineering that applies the principles of engineering, physics and materials science for analysis, design, manufacturing, and maintenance of mechanical systems. It is the branch of engineering that involves the production and usage of heat and mechanical power for the design, production and operation of machines and tools.

Program Modules-

Module I: Design and Manufacture

Module II: Engineering Fluid Mechanics

Module III: Heat Transfer

Module IV: Energy Conversion System

Module V: Mechatronics

Module VI: Manufacturing Process

Eligibility

The Eligibility for the Diploma program is 10th/ITI/Diploma holder/Working Professional in any discipline

Course Fees Details

Duration	Course Fee		Prospectus Fees	
	In INR	In USD	In INR	In USD
12 months	12000/-	240 \$	700/-	35 \$

Career Prospective:

Senior engineer
Technician
Mechanic
Supervisor



Be all that you can be...

Mechanical Engineering

PG Diploma in Mechanical Engineering (PGME)

Mechanical engineering is a discipline of engineering that applies the principles of engineering, physics and materials science for analysis, design, manufacturing, and maintenance of mechanical systems. It is the branch of engineering that involves the production and usage of heat and mechanical power for the design, production, and operation of machines and tools.

Program Modules-

Module I: Design and Manufacture

Module II: Engineering Fluid Mechanics

Module III: Heat Transfer

Module IV: Energy Conversion Systems

Module V: Mechatronics

Module VI: Manufacturing Process

Module VII: Applied Electricity

Module VIII: Strength Materials

Eligibility

The Eligibility for the PG program is Graduation in any discipline.

Course Fees Details

Duration	Course Fee		Prospectus Fees	
	In INR	In USD	In INR	In USD
12 months	14000/-	280 \$	700/-	35\$

Career Prospective:

Senior engineer
Technician
Mechanic
Supervisor

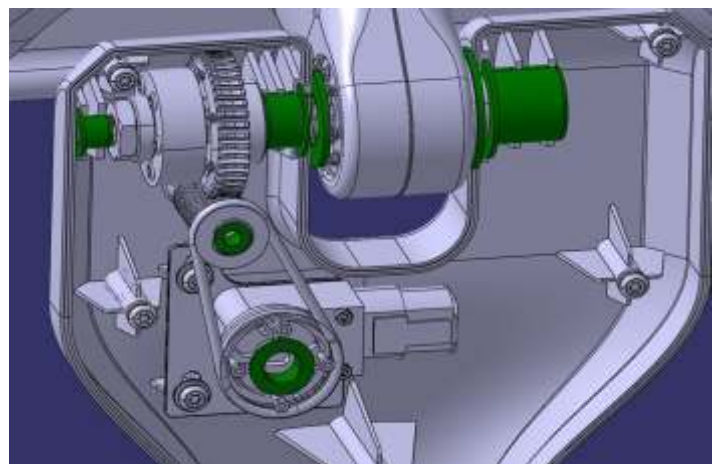

Mechanical Engineering

Advance Diploma in Mechanical Engineering (ADME) - 2 Years

Mechanical engineering is a discipline of engineering that applies the principles of engineering, physics and materials science for analysis, design, manufacturing, and maintenance of mechanical systems. It is the branch of engineering that involves the production and usage of heat and mechanical power for the design, production, and operation of machines and tools.

Program Modules-

Semester: First — Fee: 6000 INR

Module I: Design and Manufacture

Module II: Engineering Fluid Mechanics

Module III: Heat Transfer

Semester: Second — Fee: 6000 INR

Module IV: Energy Conversion Systems

Module V: Mechatronics

Module VI: Thermodynamics

Semester: Third — Fee: 6000 INR

Module IV: Manufacturing process

Module V: Applied Electricity

Module VI: Strength of Materials

Semester : Final— Fee: 6000 INR

Module IV: CAD / CAM & CNC Programming

Module V: Applied Dynamics for Technicians

Module VI: Hydraulics & Pneumatics

Eligibility

The Eligibility for this Course is Minimum Matriculation

Course Fees Details

Duration	Course Fee		Prospectus Fees	
	In INR	In USD	In INR	In USD
24 months	24000/-	480 \$	700/-	35 \$

Career Prospective:

Senior engineer
Technician
Mechanic
Supervisor



Be all that you can be...

Petrochemical Refining

Diploma Program in Petrochemical and Refining (DPPCR)

Petrochemicals are chemical products derived from petroleum. Some chemical compounds made from petroleum are also obtained from other fossil fuels, such as coal or natural gas, or renewable sources such as corn or sugar cane.

Program Modules-

Module I: Refinery and Petrochemical Processing

Module II: Process Safety and Operations Integrity

Module III: Process and Energy Integration

Module IV: Fundamentals of Petroleum and Petrochemical Engineering

Module V: Process Systems Design

Module VI: Oil and gas production

Eligibility

This eligibility for the Diploma program is ITI / Diploma holder / Working Professional in any discipline.

Course Fees Details

Duration	Course Fee		Prospectus Fees	
	In INR	In USD	In INR	In USD
12 months	12000/-	240 \$	700/-	35 \$

Career Prospective:

petrochemical engineers
Technicians
Production Engineer
QA & QC Inspector
Senior Supervisor



Be all that you can be...

Electrical Engineering - 2 Years

Advance Diploma in Electrical Engineering (DPEE) – 2 Years

Petrochemicals are chemical products derived from petroleum. Some chemical compounds made from petroleum are also obtained from other fossil fuels, such as coal or natural gas, or renewable sources such as corn or sugar cane.

Program Modules-

Semester : I

- Module 1 Elements of Electrical Engineering
- Module 2 Mechanical Engineering Sciences
- Module 3 Applied Mathematics-I
- Module 4 Applied Sciences

Semester: II

- Module 5 Electrical Circuit Laboratory
- Module 6 Electrical Circuits
- Module 7 Electronics - I
- Module 8 Applied Mathematics

Semester : III

- Module 9 Electrical and Electronics Measurement
- Module 10 Communication and Computer Network
- Module 11 Power Electronics Lab
- Module 12 Electricals Machines Lab

Semester: IV

- Module 13 Electrical Power Generation
- Module 14 Electrical Installation Design Lab
- Module 15 Embedded System Lab
- Module 16 Switchgear and Protection

Eligibility

The eligibility for this course is Minimum matriculation

Course Fees Details

Duration	Course Fee		Prospectus Fees	
	In INR	In USD	In INR	In USD
12 months	14000/-	280 \$	700/-	35\$

Career Prospective:

Electrical engineers
Technicians
Production Engineer
QA & QC Inspector
Senior Supervisor



Be all that you can be...

Fire Safety

Diploma Program in Fire and Safety (DPFS)

Fire Protection and Safety gives knowledge to students will about industrial safety standards, risk analysis, fire protection systems, factors that influence fire and hazard management. This course includes screen handling methodologies to verify that regulations are held fast and proper safety procedures are followed. The best career opportunities in this field is guaranteed as practically in each major industry there is a need to verify both the product and the workplace meeting safety criteria set by the administration

Program Modules-

Module I: Fire Sciences

Module II: Fire Protection System

Module III: Fire Dynamics, Applications and Fundamental

Module IV: Fluid Mechanics and Fire Hydraulics

Module V: Fire Detection and Alarm Systems

Module V: Industrial Hygiene and Occupational Health

Eligibility

The eligibility for the Diploma program is ITI/Diploma holder/Working Professional

Course Fees Details

Duration	Course Fee		Prospectus Fees	
	In INR	In USD	In INR	In USD
12 months	12000/-	240 \$	700/-	35 \$

Career Prospective:

Fire Man
Safety In-charge
Fire Supervisors
Senior Supervisor
Paint & Coating Developer
Paint Shop Manager:



Be all that you can be...

[Www.cisstudies.in](http://www.cisstudies.in)

info@cisstudies.in

Fire Safety

Advance Diploma in Fire and Safety (ADFS)

Fire Protection and Safety gives knowledge to students will about industrial safety standards, risk analysis, fire protection systems, factors that influence fire and hazard management. This course includes screen handling methodologies to verify that regulations are held fast and proper safety procedures are followed. The best career opportunities in this field is guaranteed as practically in each major industry there is a need to verify both the product and the workplace meeting safety criteria set by the administration

Program Modules-

Module I: Fire Sciences

Module II: Fire Protection System

Module III: Fire Dynamics, Applications and Fundamental

Module IV: Fluid Mechanics and Fire Hydraulics

Module V: Fire Detection and Alarm Systems

Module V: Industrial Hygiene and Occupational Health

Module VI: Fire Tech Design

Module VIII: Fire Control Technology

Eligibility

The Eligibility for the Advance Diploma is 10 / 10+2/ ITI / Diploma holder/Working Professional

Course Fees Details

Duration	Course Fee		Prospectus Fees	
	In INR	In USD	In INR	In USD
12 months	14000/-	240 \$	700/-	35 \$

Career Prospective:

Fire Man
Safety In-charge
Fire Supervisors
Senior Supervisor
Paint & Coating Developer
Paint Shop Manager:



Be all that you can be...

[Www.cisstudies.in](http://www.cisstudies.in)

info@cisstudies.in

Coating Inspection & QC

Advance Diploma in Coating Inspection & Quality Control (ADQC)

Fire Protection and Safety gives knowledge to students will about industrial safety, risk analysis, fire protection systems, factors that influence fire and hazard management. This course includes screen handling methodologies to verify that regulations are held fast and proper safety procedures are followed. The best career opportunities in this field is guaranteed as practically in each major industry there is a need to verify both the product and the workplace meeting safety criteria set by the administration

Program Modules-

Semester : I

Module 1: Basics of Quality
Module 2 : Statistical Quality Control
Module 3: Qualification and Validation
Module 4: Quality Assurance and Quality control

Semester : II

Module 5: Fundamentals of Quality Control and Improvement
Module 6: Quality management in mechanical
Module 7: Types of quality testing
Module 8: Quality testing tools and techniques

Semester: III

Module 9: Quality Management Systems
Module 10: Contemporary Quality Concepts
Module 11: Quality certifications, Govt. Regulations ICH Guidelines, and ISO 9000
Module 12 : Setting up quality control checks, inspections and audits

Semester: IV

Module 13: Total Quality Management
Module 14 : Risk assessment and management
Module 15: Addressing internal and external and Quality issues
Module 16 : Labrotary demonstration of QAQC Practicals and instrument handling

Eligibility

The eligibility of this course is minimum matriculation

Course Fees Details

Duration	Course Fee		Prospectus Fees	
	In INR	In USD	In INR	In USD
12 months	24000/-	280 \$	700/-	35 \$

Career Prospective:

Fire Man
Safety In-charge
Fire Supervisors
Senior Supervisor
Paint & Coating Developer
Paint Shop Manager:



Be all that you can be...

Cheminformatic

Diploma Program in Cheminformatic (DPCI)

The objective of the Program in Cheminformatic: Distance Learning program is to provide an intensive and up-to-date learning in the emerging area of Chemical sciences. The program provides a basic to advance level of expertise in Cheminformatic and its usage in the industry.

Program Modules-

Module I: Fundamentals of Cheminformatic

Module II: Medicinal Chemistry

Module III: Modern Combinatorial Chemistry

Module IV: Chemical Database Design and Their Management

Module V: Chemical Information Sources

Module VI :Introduction to Computational Chemistry

Module VII :Data Sequencing Mining

Module VIII :Drug Design and Discovery

Eligibility

The Eligibility for this program is Minimum 10th / 10+2/ Diploma/ Graduation in Science Stream

Course Fees Details

Duration	Course Fee		Prospectus Fees	
	In INR	In USD	In INR	In USD
12 months	12000/-	240 \$	700/-	35 \$

Career Prospective:

Quality Engineer
Chemist
Technical Incharge
Lab Assistane
Chemical Engineer

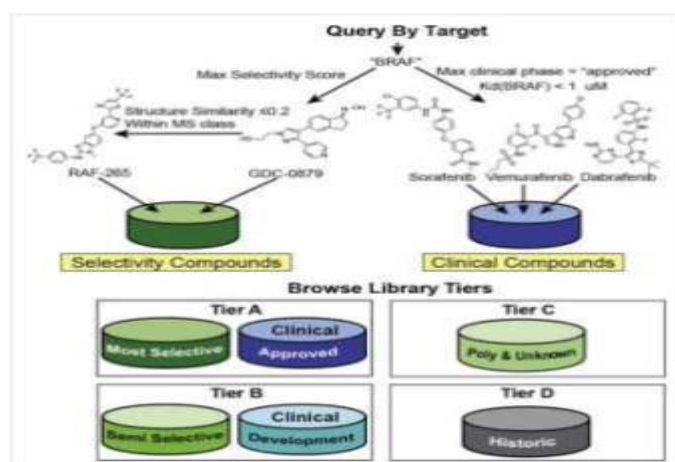

Be all that you can be...

Leather Technology

Industrial Diploma in Leather Technology (IDLT)

Leather Technology is a branch of engineering which deals with synthesis, production and refining of leather so that it can be put into efficient use. It also deals with the synthesis of artificial leather and its efficient use to make commercial goods. It is comparatively a new branch which is gaining importance in industrial sector.

Program Modules-

Module I : Fundamental of Leather Technology

Module II: Chemistry & Technology of Leather Manufacture

Module III: Leather Goods and Garments Technology

Module IV: Organization & management of Leather Manufacture

Module V: Mechatronics

Module VI: Footwear Technology

Module VII: Tanning & Post Tanning Process of Leather

Module VIII: Principles of Environmental Science & Engineering

Eligibility

The eligibility for the Diploma Course is Minimum 10 +2 Standard / ITI/ Diploma in any discipline

Course Fees Details

Duration	Course Fee		Prospectus Fees	
	In INR	In USD	In INR	In USD
12 months	12000/-	240 \$	700/-	35 \$

Career Prospective:

Leather Technologist
Material In-charge
Leather Tester
QA & QC Inspector
Senior Supervisor



Be all that you can be...

Electronics Communication

Industrial Diploma in Electronics & communication (IDEC)

Upon completion of this course, the participant will be able to:
Identify the types of paint and coatings to be used for various applications.
Understand the importance of surface preparation & the methods for achieving the same
Prepare various surfaces for painting as per internationally recognized standards.
Carry out paint application as per the given data sheets of paints, using airless spray-painting equipment.
Perform routine maintenance and repairs on Spray-painting and Grit-blasting equipment

Program Modules-

Module- I: Principles of Communication Engineering

Module- II: Electronic Devices and Circuits

Module- III: Digital Electronics

Module- IV: Principles of Communication Engineering

Module- V: Environmental Studies

Module- VI: Electrical Machines

Eligibility

Candidate must have passed 10+2 (Non-Medical)/ 10+2 Vocational (in technical field).

Course Fees Details

Duration	Course Fee		Prospectus Fees	
	In INR	In USD	In INR	In USD
12 months	12000/-	240 \$	700/-	35 \$

Career Prospective

Senior Paint Technologist
Senior Coating Analyst
Production & Development Manager
QA & QC Inspector
Senior Supervisor
Paint & Coating Developer
Paint Shop Manager:



Ink & Printing

Advance Diploma in Ink & Printing Technology (ADIPT)

Printing technology courses can be taken as part of a diploma, certificate or associate's degree program in printing, printing technology or press/pre-press technology. In addition, there are a handful of schools that offer bachelor's programs in printing technology or printing engineering. Some degree programs require that the school has a relationship with the student's employer, while some short-term programs are geared toward those already possessing experience or credentials in graphic design or printing. Here are some common concepts found in printing technology courses:

Program Modules-

Module I: Press Operations and Techniques

Module II: Lithography and Offset Printing

Module III: Digital Printing

Module IV: Graphics and Design

Module V: Ink Technologies and Manufacture

Module VI: Contemporary Quality Concepts

Eligibility

The eligibility for the Program is 12th / ITI/ Diploma in any stream

Course Fees Details

Duration	Course Fee		Prospectus Fees	
	In INR	In USD	In INR	In USD
12 months	12000/-	240 \$	700/-	35 \$

Career Prospective:

Ink Chemist
Paper technician
Engineer



Ink & Printing

PG Diploma in Ink & Printing Technology (PGIPT)

Printing technology courses can be taken as part of a diploma, certificate or associate's degree program in printing, printing technology or press/pre-press technology. In addition, there are a handful of schools that offer bachelor's programs in printing technology or printing engineering. Some degree programs require that the school has a relationship with the student's employer, while some short-term programs are geared toward those already possessing experience or credentials in graphic design or printing.

Program Modules-

Module I: Press Operations and Techniques

Module II: Lithography and Offset Printing

Module III: Digital Printing

Module IV: Graphics and Design

Module V: Ink Technologies and Manufacture

Module VI: Contemporary Quality Concepts

Module VII: Reproduction Technology

Module VIII: Image Carrier Technology

Eligibility

The eligibility for this Course is Minimum Graduation in any stream

Course Fees Details

Duration	Course Fee		Prospectus Fees	
	In INR	In USD	In INR	In USD
12 months	14000/-	280 \$	700/-	35\$

Career Prospective:

Ink Chemist
Paper technician
Engineer



Be all that you can be...

Polymer Science

Industry Program in Polymer Engineering (IPPE)

Paint technology involves understanding the chemistry of the functions ... in boom there is some scope for paint technology as a career avenue

Program Modules-

Module I: Introduction To Polymer science

Module II: Polymer Chemistry

Module III: Paints , Coatings & Adhesives

Module IV: Polymer Additive and Compounding

Module V: Polymer Testing and Specifications

Module VI: Polymer Blends & Composites

Eligibility

This Program is designed for everyone

Course Fees Details

Duration	Course Fee		Prospectus Fees	
	In INR	In USD	In INR	In USD
12 months	12000/-	240 \$	700/-	35 \$

Career Prospective

Senior Paint Technologist
Senior Coating Analyst
Production & Development Manager
QA & QC Inspector
Senior Supervisor
Paint & Coating Developer
Paint Shop Manager:

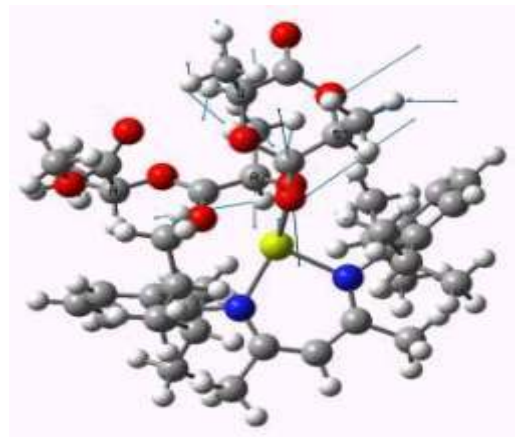

Be all that you can be...

Ink & Printing

Advance Diploma in Ink & Printing Technology (ADPT) - 2 Years

Printing technology courses can be taken as part of a diploma, certificate or associate's degree program in printing, printing technology or press/pre-press technology. In addition, there are a handful of schools that offer bachelor's programs in printing technology or printing engineering. Some degree programs require that the school has a relationship with the student's employer, while some short-term programs are geared toward those already possessing experience or credentials in graphic design or printing. Here are some common concepts found in printing technology courses:

Program Modules-

Semester : I

Module 1 Press Operations and Techniques
Module 2 Lithography and Offset Printing
Module 3 Digital Printing

Semester; II

Module 4 Graphics and Design
Module 5 Ink Technologies and Manufacture
Module 6 Contemporary Quality Concept

Semester: III

Module 7 Reproduction Technology
Module 8 Image Carrier Technology
Module 9 Flexographic Printing

Semester: IV

Module 10 Block printing or Screen Printing
Module 11 Introduction to Digital printing,
ink-jet printing Principle
Module 12 Transfer printing ,transfer paper
printing ,dyes and inks

Eligibility

The eligibility for the Program is 12th / ITI/ Diploma in any stream

Course Fees Details

Duration	Course Fee		Prospectus Fees	
	In INR	In USD	In INR	In USD
12 months	24000/-	480 \$	700/-	35 \$

Career Prospective:

Ink Chemist
Paper technician
Engineer



Be all that you can be...

Corrosion Technology

Industrial Diploma in Corrosion Technology (IDCT)

Polymer Engineering or Macromolecular Science is the subfield of materials science concerned with polymers, primarily synthetic polymers such as plastics. The field of polymer science includes researchers in multiple disciplines including chemistry, physics, and engineering. The course includes chemistry, physics, chemical engineering and biochemistry. Polymer science is the study of the materials of everyday life and the development of new materials that meet societal and technological needs. Course structure introduces the students to Polymers that are usually manufactured in the form of fibres, yarns, flakes and granules.

Program Modules-

Module I: Introduction To Corrosion Technology

Module II: Chemistry of Corrosion

Module III: Corrosion Electrochemistry

Module IV: Corrosion Kinetics

Module V: Atmospheric Corrosion

Module VI: Corrosion Factors & Cells

Eligibility

The eligibility for the Program is 12th / ITI/ Diploma in any stream

Course Fees Details

Duration	Course Fee		Prospectus Fees	
	In INR	In USD	In INR	In USD
12 months	12000/-	240 \$	700/-	35 \$

Career Prospective

Senior Paint Technologist
Senior Coating Analyst
Production & Development Manager
QA & QC Inspector
Senior Supervisor
Paint & Coating Developer
Paint Shop Manager:



Be all that you can be...

Resins, Pigments

Industrial Diploma in Resins, Pigments and Allied Science (IDSR)

Pigment & Resin Technology provides unrivalled coverage of the formulation and manufacture of paints, coatings, dyes, inks, adhesives, sealants and varnishes. Authoritative and up to date, it keeps you fully informed about the latest technical and commercial developments worldwide. Now augmented by research articles, this detailed journal is a key resource for those seeking to develop environmentally-friendly, safe, clean products which meet customers' needs. It provides practical guidance you can use immediately to resolve current problems, as well as expert knowledge to broaden your understanding and provide a platform for further research and development.

Program Modules-

Module I: Introduction To Paint Technology

Module II: Solvent, Thinners & Diluents in Paint Industry

Module III: Introduction To Paint Manufacturing

Module IV: Resin, Pigments and Solvents

Module V: Powder Coating & Its Technology

Module VI: Paint Emulsion and Additives

Eligibility

The eligibility for the Program is 12th / ITI/ Diploma in Science stream

Course Fees Details

Duration	Course Fee		Prospectus Fees	
	In INR	In USD	In INR	In USD
12 months	12000/-	240 \$	700/-	35 \$

Career Prospective

Senior Paint Technologist
Senior Coating Analyst
Production & Development Manager
QA & QC Inspector
Senior Supervisor
Paint & Coating Developer
Paint Shop Manager:



Be all that you can be...

www.cisstudies.in

info@cisstudies.in

Plastic Moulding

Industrial Diploma in Plastic Mould Technology (IPPT)

This course is designed to provide participants with the fundamental knowledge in plastic materials and processing. An emphasis is given to the plastic injection moulding process, where majority of the plastic industry are concentrated in this area. Characteristics of major plastic materials are explained with theoretical approach. Common plastic processing techniques in manufacturing are explained to give a broad idea of available methods, for example injection molding, extrusion, blow moulding.

Program Modules-

Module I: Introduction To Plastic Science

Module II: Metrology & Measuring Instruments

Module III: Design of Dies & Moulds

Module IV: Materials & Metallurgy

Module V: Plastic Process Technique

Module VI: Industrial Management

Eligibility

The eligibility for the Program is 12th / ITI/ Diploma

Course Fees Details

Duration	Course Fee		Prospectus Fees	
	In INR	In USD	In INR	In USD
12 months	12000/-	240 \$	700/-	35 \$

Career Prospective:

Moulding Engineer
Senior Mould Analyst
Production & Development Manager
QA & QC Inspector
Senior Supervisor
Paint & Coating Developer
Manager:

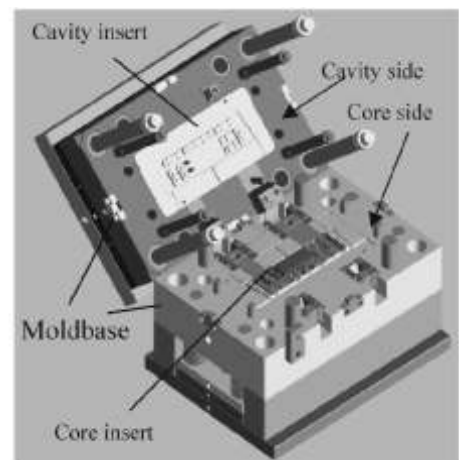

Be all that you can be...

Paper Pulp

Industrial Diploma in Paper & Pulp Technology (DPPT)

The pulp is fed to a paper machine where it is formed as a paper web and the water is removed from it by pressing and drying. Pressing the sheet removes the water by force. Once the water is forced from the sheet, a special kind of felt, which is not to be confused with the traditional one, is used to collect the water. Whereas, when making paper by hand, a blotter sheet is used instead. Drying involves using air or heat to remove water from the paper sheets. In the earliest days of paper making, this was done by hanging the sheets like laundry.

Program Modules-

Module I: Fundamental of Pulp & Paper Technology

Module II: Introduction to Fluid Mechanics

Module III: Particle machine

Module IV: Paper making process & its Characteristics

Module V: Environmental Behavior

Module VI: Heat Transfer

Eligibility

The eligibility for the Diploma Course is Minimum 10 +2 Standard / ITI/ Diploma in any discipline

Course Fees Details

Duration	Course Fee		Prospectus Fees	
	In INR	In USD	In INR	In USD
12 months	12000/-	240 \$	700/-	35\$

Career Prospective

Senior Paper Technologist
Senior pulp Analyst
Production & Development Manager
QA & QC Inspector
Senior Supervisor



Paper Pulp

PG Diploma in Paper & Pulp Technology (PGPPT)

The pulp is fed to a paper machine where it is formed as a paper web and the water is removed from it by pressing and drying. Pressing the sheet removes the water by force. Once the water is forced from the sheet, a special kind of felt, which is not to be confused with the traditional one, is used to collect the water. Whereas, when making paper by hand, a blotter sheet is used instead. Drying involves using air or heat to remove water from the paper sheets. In the earliest days of paper making, this was done by hanging the sheets like laundry.

Program Modules-

Module I: Fundamental of Pulp & Paper Technology

Module II: Introduction to Fluid Mechanics

Module III: Particle machine

Module IV: Paper making process & its Characteristics

Module V: Environmental Behavior

Module VI: Heat Transfer

Eligibility

The eligibility for the Diploma Course is Minimum Graduation

Course Fees Details

Duration	Course Fee		Prospectus Fees	
	In INR	In USD	In INR	In USD
12 months	14000/-	280 \$	700/-	35\$

Career Prospective

Senior Paper Technologist
Senior pulp Analyst
Production & Development Manager
QA & QC Inspector
Senior Supervisor



Sugar Alcohol

Diploma Program in Sugar & Alcohol Technology (DPSAT)

Alcohol Technology aims to help distillery industry in their efforts to achieve the economic development with minimum use of resources and energy input) by assisting them in building their capacity and capability through trained manpower and by way of advancement, development and adoption of better technology in its area of focus viz. fermentation, distillation & integrated effluent treatment systems.

Program Modules-

Module I: Introduction To Sugar Technology

Module II: Chemical & Physical Methods of Sugar analysis

Module III: Enzymes in fermentation industry

Module IV: Fundamental of Alcohol Technology & Production

Module V: Unit Operations & Management

Module VI: Boilers Exposure

Eligibility

The eligibility for the Program is 12th / ITI/ Diploma

Course Fees Details

Duration	Course Fee		Prospectus Fees	
	In INR	In USD	In INR	In USD
12 months	12000/-	240 \$	700/-	35\$

Career Prospective:

Chemist
Chemical Engineer
Production & Development Manager
Sugar Tester
Alcohol Analyst

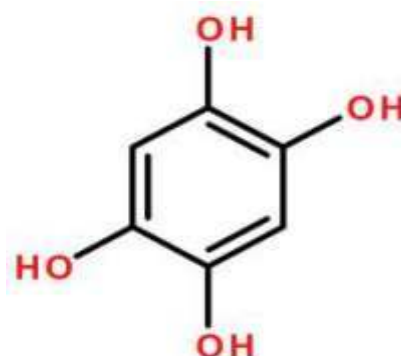

Sugar Alcohol

PG Diploma in Sugar & Alcohol Technology (PGSAT)

Alcohol Technology aims to help distillery industry in their efforts to achieve the economic development with minimum use of resources and energy input) by assisting them in building their capacity and capability through trained manpower and by way of advancement, development and adoption of better technology in its area of focus viz. fermentation, distillation & integrated effluent treatment systems.

Program Modules-

Module I: Introduction To Sugar Technology

Module II: Chemical & Physical Methods of Sugar analysis

Module III: Enzymes in fermentation industry

Module IV: Fundamental of Alcohol Technology & Production

Module V: Unit Operations & Management

Module VI: Boilers Exposure

Eligibility

The eligibility for the Program is minimum Graduation

Course Fees Details

Duration	Course Fee		Prospectus Fees	
	In INR	In USD	In INR	In USD
12 months	14000/-	280 \$	700/-	35\$

Career Prospective:

Chemist
Chemical Engineer
Production & Development Manager
Sugar Tester
Alcohol Analyst

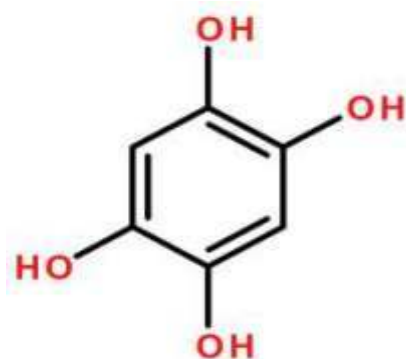

Be all that you can be...

Welding Fabrication

Advance Diploma in Welding & Fabrication (DPWF)

Adhere to industry-approved standards set out by relevant codes, legislation, and specifications; Fabricate complex shop projects using engineering drawings. Troubleshoot mechanical problems; recommend solution for repairing and maintaining equipment to industry standard..

Program Modules-

Module I: Introduction to Welding Fundamentals

Module II: Welding Processes & Practices

Module III: Shielded Metal Arc Welding

Module IV: Gas / Metal Arc Welding

Module V: Gas/Tungsten Arc Welding

Module VI: Managing Welding Projects

Eligibility

The eligibility for the training program is Diploma / ITI / HSC

Course Fees Details

Duration	Course Fee		Prospectus Fees	
	In INR	In USD	In INR	In USD
12 months	12000/-	240 \$	700/-	35 \$

Career Prospective

Welder
Engineer
Fabricator
Inspector
Senior Supervisor



Be all that you can be...

Powder Coating

Industrial Diploma in powder coating technology (IPPCT)

The paint & coating industry is economically dynamic and growing rapidly. At all times, this industry needs to appoint a good number of professionals with a focused background in the latest & upcoming domains of chemical related sciences apart from traditional paint & coating knowledge. Paint Technology has expanded spectrum and our responsibility is to collect all the relevant data from the paint domain where the candidates, working professionals, students may able to get the best with the glimmer of a new ideas.

Program Modules-

Module 1: An Introduction to Paints & its Applications

Module 2: Production & Manufacturing of Paints

Module 3: Solvent, Thinners & Diluents in Paint Industry

Module 4: The Various Types of Coatings

Module 5: The Coating Technology

Module 6: Emulsion & Paint Additives.

Module 7: Basics of Powder Coating & Electroplating

Module 8: Powder Coating Methodology

Eligibility

The eligibility for the Diploma Course is Minimum 10 +2 Standard / ITI / Diploma in any discipline

Course Fees Details

Duration	Course Fee		Prospectus Fees	
	In INR	In USD	In INR	In USD
12 months	12000/-	240 \$	700/-	35 \$

Career Prospective

Senior Paint Technologist
Senior Coating Analyst
Production & Development Manager
QA & QC Inspector
Senior Supervisor
Paint & Coating Developer
Paint Shop Manager:



Be all that you can be...

Automotive Paint Technology

Industrial Diploma in Automotive Paint Technology (IPAT)

We provide specialization diploma courses in paint coating technology in distance learning mode i.e. via correspondence. The prime aim of distance learning diploma course/program in Paint and Coating Technology is to provide compact & intense learning in the emerging domain of Paint Coating Technology & its related fields. This program provides basic to advance level of expertise as per the global paint industry demand. Join the best distance learning in automotive technology to learn new skills & upgrade yourself for tomorrow.

Program Modules-

Module 1: An Introduction to Paints & its Application

Module 2: Production & Manufacturing of Paints

Module 3: Solvent, Thinners & Diluents in Paint Industry

Module 4: Fundamental of Automotive Paints

Module 5: The Science of Rheology.

Eligibility

The eligibility for the Diploma Course is Minimum 10 +2 Standard / ITI/ Diploma in any discipline

Course Fees Details

Duration	Course Fee		Prospectus Fees	
	In INR	In USD	In INR	In USD
12 months	12000/-	240 \$	700/-	35 \$

Career Prospective

Senior Paint Technologist
Senior Coating Analyst
Production & Development Manager
QA & QC Inspector
Senior Supervisor
Paint & Coating Developer
Paint Shop Manager:



Be all that you can be...

[Www.cisstudies.in](http://www.cisstudies.in)

info@cisstudies.in

Retail Management

PG Diploma in Retail Management (PGRM)

PG Program is designed for Retail Management gives knowledge to students will about industrial management risk analysis, fire protection systems, factors that influence fire and hazard management. This course includes screen handling methodologies to verify that regulations are held fast and proper safety procedures are followed. The best career opportunities in this field is guaranteed as practically in each major industry there is a need to verify both the product and the workplace meeting safety criteria set by the administration.

Module I: Fundamental of Public Relations

Module II: Promotion Management

Module III: Research Project in Marketing

Module IV: E-Commerce in Business

Module V: Contemporary issues in Marketing

Module VI: Retail Store Management

Module VI: Fundamental of Retail Buying

Module VI: Retail Planning & Operations

Eligibility

The eligibility for PG program is Graduate any discipline.

Course Fees Details

Duration	Course Fee		Prospectus Fees	
	In INR	In USD	In INR	In USD
12 months	12000/-	240 \$	700/-	35\$

Career Prospective

Manager
Marketing Executive
Production & Development Manager
Senior Supervisor



Security Operation

PG Diploma Program in Security Operation (PGSO)

PG Program is designed for security to gives knowledge to students will about industrial security, risk analysis, fire protection systems, factors that influence fire and hazard management. This course includes screen handling methodologies to verify that regulations are held fast and proper safety procedures are followed. The best career opportunities in this field is guaranteed as practically in each major industry there is a need to verify both the product and the workplace meeting safety criteria set by the administration.

Program Modules-

Module I: Communicate Effectively in the Security Industry

Module II: Work Effectively in the Security Industry

Module III: Respond To Security Risk Situation

Module IV: Work As Part of A Security Team

Module V: Provide Security Services To Clients

Module VI: Control Access to and Exit From Premises

Module VII: Protect Safety of Persons

Module VIII: Operate Basic Security Equipment

Eligibility

The eligibility for PG program is Graduate any discipline.

Course Fees Details

Duration	Course Fee		Prospectus Fees	
	In INR	In USD	In INR	In USD
12 months	10000/-	300 \$	700/-	25\$

Career Prospective

Security Incharge Technical
Senior Security Analyst
Key Manager
Data Analyst
Senior Supervisor



Automobile Engineering

PG Diploma in Automobile Engineering (PGAE)

PG Program is designed for Retail Management gives knowledge to students will about industrial management, risk analysis, fire protection systems, factors that influence fire and hazard management. This course includes screen handling methodologies to verify that regulations are held fast and proper safety procedures

Program Modules-

Module I: Automotive Design and Manufacturing

Module II: Engine Principles

Module III: Fluid Mechanics and Machinery

Module IV: CAD/CAM Technology in Automotive Engineering

Module V: Fuel and Emission Control Systems

Module VI: Vehicle Technology and Dynamics

Module VII: Manufacturing Methods

Module VII: Engineering Analysis & Numerical Methods

Eligibility

The eligibility for PG program is Graduate any discipline.

Course Fees Details

Duration	Course Fee		Prospectus Fees	
	In INR	In USD	In INR	In USD
12 months	12000/-	360 \$	500/-	25\$

Career Prospective

Senior Paint Technologist
Senior Coating Analyst
Production & Development Manager
QA & QC Inspector
Senior Supervisor
Paint & Coating Developer
Paint Shop Manager:



Be all that you can be...

Environmental

ADVANCE DIPLOMA IN ENVIRONMENTAL SCIENCE (ADES)

Upon completion of this course, the participant will be able to:

Identify the types of paint and coatings to be used for various applications.

Understand the importance of surface preparation & the methods for achieving the same

Prepare various surfaces for painting as per internationally recognized standards.

Carry out paint application as per the given data sheets of paints, using airless spray-painting equipment.

Perform routine maintenance and repairs on Spray-painting and Grit-blasting equipment

Program Modules-

Module 1 Fundamentals of Environmental Science and Ecology

Module 2 Environmental Policy and Conflict Management

Module 3 Ecological Resources Conversation

Module 4 Environmental Planning for the Future

Module 5 Environmental Pollution, Control and Management

Module 6 Sustainable Natural Resource Management

Module 7 Environmental and Biological Conservation

Module 8 Global Strategies to Sustainable Development

Eligibility;

The Eligibility for the program is Min. Matriculation

Course Fees Details

Duration	Course Fee		Prospectus Fees	
	In INR	In USD	In INR	In USD
12 months	14000/-	280 \$	700/-	35\$

Career Prospective

Senior Paint Technologist
Senior Coating Analyst
Production & Development Manager
QA & QC Inspector
Senior Supervisor
Paint & Coating Developer
Paint Shop Manager:



Paint Coating Technology

Diploma Program in Paint Chemistry & Chemical Engineering (DPCC)

Upon completion of this course, the participant will be able to:

- Identify the types of paint and coatings to be used for various applications.
- Understand the importance of surface preparation & the methods for achieving the same
- Prepare various surfaces for painting as per internationally recognized standards.
- Carry out paint application as per the given data sheets of paints, using airless spray-painting equipment.
- Perform routine maintenance and repairs on Spray-painting and Grit-blasting equipment

Program Modules-

Semester: I

- Module 1 Professional Communication
- Module 2 Introduction to Paint Technology
- Module 3 Fundamentals of Chemistry
- Module 4 General Chemistry
- Module 5 Techniques of Process Stimulation

Semester : II

- Module 6 Physical Chemistry of Chemical Engineering
- Module 7 Resin Technology-I
- Module 8 Paint Technology-II
- Module 9 Application Techniques I
- Module 10 Chemical Engineering Thermodynamics

Semester : III

- Module 11 Production and Operations Management
- Module 12 Protective Coating I
- Module 13 Quality Management
- Module 14 Industrial Coatings
- Module 15 Automotive Paints and Coatings

Semester : IV

- Module 16 Coatings Formulation
- Module 17 Advance Paint Finishing Technology
- Module 18 Surface Chemistry & Engineering
- Module 19 Safety, Health and Environment
- Module 20 Emulsion, Polymerization & Latex Application

Eligibility;

The eligibility for the Advance program is Diploma / ITI / HSC .

Course Fees Details

Duration	Course Fee		Prospectus Fees	
	In INR	In USD	In INR	In USD
12 months	32000/-	640 \$	700/-	35\$

Career Prospective

- Senior Paint Technologist
- Senior Coating Analyst
- Production & Development Manager
- QA & QC Inspector
- Senior Supervisor
- Paint & Coating Developer
- Paint Shop Manager:



Sales Marketing

PG Diploma in Sales & Marketing (PGSM)

Upon completion of this course, the participant will be able to:

Identify the types of paint and coatings to be used for various applications.

Understand the importance of surface preparation & the methods for achieving the same

Prepare various surfaces for painting as per internationally recognized standards.

Carry out paint application as per the given data sheets of paints, using airless spray-painting equipment.

Perform routine maintenance and repairs on Spray-painting and Grit-blasting equipment

Program Modules-

Module 1 Basic processes of sales, marketing and marketing management

Module 2 Sales and marketing- basic functions, characteristics and roles in the market

Module 3 The nature and culture of markets

Module 4 Digital Marketing

Module 5 Consumer behavior and buying trends of the market

Module 6 Market segmentation, market targeting and market positioning

Module 7 Analysis techniques for market competition study

Module 8 Market research and study of market potentials

Eligibility;

The Eligibility for the PG program is Min. Graduation from any recognized university in any Discipline.

Course Fees Details

Duration	Course Fee		Prospectus Fees	
	In INR	In USD	In INR	In USD
12 months	14000/-	280 \$	700/-	35\$

Career Prospective

Senior Paint Technologist
Senior Coating Analyst
Production & Development Manager
QA & QC Inspector
Senior Supervisor
Paint & Coating Developer
Paint Shop Manager:



Packaging Technology

Industrial Diploma in Flexible Packaging Technology (DFPT)

Upon completion of this course, the participant will be able to:

- Identify the types of paint and coatings to be used for various applications.
- Understand the importance of surface preparation & the methods for achieving the same
- Prepare various surfaces for painting as per internationally recognized standards.
- Carry out paint application as per the given data sheets of paints, using airless spray-painting equipment.
- Perform routine maintenance and repairs on Spray-painting and Grit-blasting equipment

Program Modules-

Module 1 Packaging Materials & Characterization

Module 2 Product Package Development

Module 3 Package Printing Technology

Module 4 Ancillary Packaging Materials

Module 5 Communication Skill & Report Writing

Module 6 Plastics Processing & Conversion Technologies

Module 7 Entrepreneurship Evolution & Management

Module 8 Transport Simulation Laboratory

Eligibility;

The Eligibility for the Diploma program is 10th/ITI/Diploma holder/Working Professional in any discipline.

Course Fees Details

Duration	Course Fee		Prospectus Fees	
	In INR	In USD	In INR	In USD
12 months	14000/-	280 \$	700/-	35\$

Career Prospective

Senior Paint Technologist
Senior Coating Analyst
Production & Development Manager
QA & QC Inspector
Senior Supervisor
Paint & Coating Developer
Paint Shop Manager:



Food Technology

ADVANCE DIPLOMA IN FOOD TECHNOLOGY (ADFT)

Food Technology a scientific discipline, encompasses the intricate methodologies and practices entwined in the realms of food production, processing, preservation, packaging, labelling, quality assurance, and distribution. This multifaceted concept revolves around the conversion of raw materials into consumable and nourishing food products. Fueled by research-driven pursuits, an extensive array of Food Technology courses has emerged globally, imparted by educational institutions, to nurture adept professionals catering to diverse sectors including healthcare facilities culinary establishments, dining establishments, and food processing enterprises among others.

Program Modules-

Module 1 Fundamentals of food processing

Module 2 Management of food processing industries

Module 3 Food industry waste management

Module 4 plant safety and hazard analysis

Module 5 Food fermentation technology

Module 6 Refrigeration and air conditioning

Module 7 Dairy plant engineering

Module 8 Fat and oil processing technology

Eligibility;

The Eligibility for the Diploma Course is Min. 12th in any discipline

Course Fees Details

Duration	Course Fee		Prospectus Fees	
	In INR	In USD	In INR	In USD
12 months	14000/-	280 \$	700/-	35\$

Career Prospective

Senior Paint Technologist
Senior Coating Analyst
Production & Development Manager
QA & QC Inspector
Senior Supervisor
Paint & Coating Developer
Paint Shop Manager:



Civil

ADVANCE DIPLOMA IN CIVIL ENGINEERING (ADCE)

If you get fascinated by tall and magnificent structures all around, there could be a hidden architect within you. Civil Engineering is a field that is concerned with aesthetic designs of buildings and the one who does the job is Civil Engineer.

Program Modules-

Semester I

- Module 1 Hydraulics and Hydraulic Machines
- Module 2 Concrete Technology
- Module 3 Reinforced Cement Concrete Structures (RCC Structures)
- Module 4 Energy Conservation

Semester II

- Module 5 RCC Drawing
- Module 6 Soil Mechanics and Foundation Engineering
- Module 7 Waste Water and Irrigation Engineering Drawing
- Module 8 Quantity Surveying and Valuation

Semester III

- Module 9 Construction Management, Accounts and Entrepreneurship Development
- Module 10 Design of Steel Structure
- Module 11 Software Application in Civil Engineering
- Module 12 Evaluation Strategy

Semester IV

- Module 13 Basics of Information Technology
- Module 14 Basics of Mechanical and Electrical Engg.
- Module 15 Applied Physics
- Module 16 Construction Materials

Eligibility;

The Eligibility for the PG program is Min.Matriculation

Course Fees Details

Duration	Course Fee		Prospectus Fees	
	In INR	In USD	In INR	In USD
12 months	24000/-	480 \$	700/-	35\$

Career Prospective

Senior Paint Technologist
Senior Coating Analyst
Production & Development Manager
QA & QC Inspector
Senior Supervisor
Paint & Coating Developer
Paint Shop Manager:



COMPUTER SCIENCE

ADVANCE DIPLOMA IN COMPUTER APPLICATION (ADCA)

Advance Diploma in Computer Science is a specialized program designed for individuals seeking in-depth knowledge and skills in the field of computer science. This diploma offers advanced training in various aspects of computer science, including programming, software development, database management, networking, and system administration. It is an ideal choice for individuals who want to enhance their career prospects in the ever-evolving field of technology

Program Modules-

Module 1 Computer Fundamentals & Applications

Module 2 Database Management System

Module 3 Operating system

Module 4 Multimedia technology & application

Module 5 Object-oriented programming in C++

Module 6 Wireless and Mobile Communication

Module 7 Network Installation & management

Module 8 Software engineering principles

Eligibility;

The Eligibility for the Diploma Course is Min. ITI / Diploma / 10th /12th in any discipline

Course Fees Details

Duration	Course Fee		Prospectus Fees	
	In INR	In USD	In INR	In USD
12 months	14000/-	280 \$	700/-	35\$

Career Prospective

Senior Paint Technologist
Senior Coating Analyst
Production & Development Manager
QA & QC Inspector
Senior Supervisor
Paint & Coating Developer
Paint Shop Manager:



Be all that you can be...

www.cisstudies.in

info@cisstudies.in

Textiles

ADVANCE DIPLOMA IN TEXTILE DESIGN (ADTD)

The diploma in Textile design comes with several skills like learning to analyse a Fabric and visualization with several elements in the Fabric, learning to read a colour palette, learning to match colour to tones, understanding yarns and threads etc.

These skills help in the long run, whether as an assistant designer or a Textile decorator. The prime benefit is that the course duration is short but the basic principles behind Textile design and Fabric management are communicated during the same

Program Modules-

Module 1 Basic textile knitting

Module 2 Introduction to textile art and craft

Module 3 Introduction to textiles

Module 4 Structural fabric designing

Module 5 Dyeing and printing

Module 6 Freehand Drawing and painting

Module 7 Waste management in fashion and textile design

Module 8 Elements of fashion and apparel design

Eligibility;

The eligibility for the Program is 12th in any Discipline

Course Fees Details

Duration	Course Fee		Prospectus Fees	
	In INR	In USD	In INR	In USD
12 months	14000/-	280 \$	700/-	35\$

Career Prospective

Senior Paint Technologist
Senior Coating Analyst
Production & Development Manager
QA & QC Inspector
Senior Supervisor
Paint & Coating Developer
Paint Shop Manager:



Be all that you can be...

www.cisstudies.in

info@cisstudies.in

Textiles

Industrial Diploma in Fitter (IDFT)

The demand for the work of Fitter is too high in the Private sector. The candidates will be able to make career in industries in India or abroad. Not only this, but one will also be equipped to start your own business in this field.

Program Modules-

Module 1 Theoretical Concepts of Fitter

Module 2 Personality and Skill Development

Module 3 Engineering Drawing

Module 4 Measurement

Module 5 Lathe machine

Module 6 Pipe joints

Module 7 Drilling

Module 8 Hydraulics

Eligibility;

The eligibility for the Program is 10th in any Discipline

Course Fees Details

Duration	Course Fee		Prospectus Fees	
	In INR	In USD	In INR	In USD
12 months	14000/-	280 \$	700/-	35\$

Career Prospective

Fitter
Pipe Fitter
Lathe Machine Fitter
Trainer



REFRIGERATION & AIR CONDITIONING

ADVANCE DIPLOMA IN REFRIGERATION & AIR CONDITIONING

The main purpose of using air conditioning and refrigeration is to lower the temperature of a particular area compared to the surroundings

Program Modules-

Semester I

- Module 1 Communication Skills
- Module 2 Repairing & Preventive Maintenance of refrigeration , air conditioning
- Module 3 Basic of Refrigeration & Air Conditioning
- Module 4 Refrigeration Systems
- Module 5 Air Conditioning Systems

Semester II

- Module 5 Familiarized with concepts and working of cold chain
- Module 6 Functioning of district cooling systems
- Module 7 Process of centralized air condition systems
- Module 8 Heat and Energy
- Module 10 Latent Heat and the operation of Refrigeration

Semester III

- Module 1 The Pressure Enthalpy Diagram
- Module 2 Evaporators and Compressors
- Module 3 Compressor Performance
- Module 4 Condensers and Liquid Receivers
- Module 5 Evaporator Liquid Feed Control

Semester IV

- Module 13 Refrigeration System Ancillaries
- Module 14 System Lubrication and compressors malfunction
- Module 15 Compressor Electrical Failure and control
- Module 16 Centralized air conditioning system
- Module 20 Auto CAD Revit MEP

Eligibility;

The Eligibility for the PG program is Min. Matriculation

Course Fees Details

Duration	Course Fee		Prospectus Fees	
	In INR	In USD	In INR	In USD
12 months	24000/-	480 \$	700/-	35\$

Career Prospective

Senior Paint Technologist
Senior Coating Analyst
Production & Development Manager
QA & QC Inspector
Senior Supervisor
Paint & Coating Developer
Paint Shop Manager:





Cheminformatic Institute of Science (CIS) Studies Lucknow

Undertaking Shivi Professional Academy OPC Pvt Ltd

Registered by Government of India, Ministry of Corporate Affairs

Corporate Office Address : SF-5, LDA Complex, Vibhav Khand-4, Gomti Nagar , Lucknow- 226010 (UP) INDIA

Tele:- 0522 - 3590661 Mob : +91- 95 59 196 700, +91- 95 54 064 000

Application Form For Admission

Paste your self attested photograph

To
The Admission Cell
Cheminformatic Institute of Science (CIS) Studies Lucknow

Sir
I am Desirous of seeking admission in your Institute and I am accordingly Submitting the required information as under:-

Participation No. (For office use only) [Grid]

Course:

All columns are compulsory, No column should be left blank, All in block letters

1. Candidate's Name* [Grid]

2. Father's / Husband's Name* [Grid]

3. Date of Birth* [Grid] (D D M M Y Y Y Y)

4. Gender Male [] Female []

5. Address for Correspondence* Village / H. No: [Grid]

Post / Town: [Grid]

Dist / City: [Grid] PIN [Grid]

6. Telephone No. (if any)* [Grid] Mo: [Grid]

7. E-mail* [Grid]

8. Last Academic Qualifications* [Table with columns: Exam Passed, Board / University, Year, Result with Percentage]

9. Work Experience (If Applicable) [Table with columns: Full Name of the organization, Designation, Total Work Exp. (In yrs.)]

Payment Details:

10. Crossed Cheque / Cash / Demand Draft No. _____ Dated _____ Drawn on _____ for Rs. _____

(Bank Draft/ Cheque must be drawn in favour of "CIS Studies, Lucknow" payable at "Lucknow". Candidates are advised to write their name and address at the back of demand draft / Cheque)

You may also pay the Corse Fee by Online Internet Banking / NEFT / RTGS in Institute Account.

Google Pay/ Phone Pay: 9554064000

*Only at par / Multicity cheque will be accepted

11 Documents to be attached with application form:

- i) Fee DD/ Cheque ii) Photocopies of Academic Qualification iii) 2 Copies of Passport size photograph one pasted and one pinned

Note: At par Cheque only accepted.

*Mandatory to fill

**Declaration by the Participant

I hereby declare that I have read and understood the conditions of eligibility and objectives of the program for which I seek participation and am eligible for the same. I understand that this is Cheminformatic Institute of Science Studies Lucknow (CIS Studies Lucknow) independent knowledge enhancement Distance Learning / Certificate/ Diploma program which is professional in nature and the enrollment in / completion of the program does not promise any employment or any specific eligibility to pursue higher studies. Disputes if any are subject to jurisdiction of Lucknow, District Lucknow Courts only. I also understand that the fee is non refundable and nor shall the fee will be transferred or adjusted in any other program or service.

Date : / /

Place :

Signature of the Participant

पेंट ऐंड कोटिंग टेक्नोलॉजी

कैरियर में भरें रंग

पेंट टेक्नोलॉजी में बीटेक कोर्स के अलावा डिप्लोमा और पीजी डिप्लोमा जैसे कोर्स भी कैरियर के दृष्टिकोण से महत्वपूर्ण हैं...



कोर्स कैसे-कैसे

इस क्षेत्र में बेहतर कैरियर के मद्देनजर 4 वर्षीय बीटेक कोर्स में दाखिला लिया जा सकता है। इसके अलावा डिप्लोमा प्रोग्राम इन पेंट ऐंड कोटिंग एप्लीकेशन, पीजी प्रोग्राम इन पेंट ऐंड कोटिंग एप्लीकेशन, एडवॉंस प्रोग्राम इन पेंट ऐंड कोटिंग टेक्नोलॉजी, सर्टिफिकेट प्रोग्राम इन पेंट ऐंड कोटिंग एप्लीकेशन जैसे कोर्सेज भी किए जा सकते हैं।

ऐसे मिलता है

पाठ्यक्रमों में दाखिला

विभिन्न संस्थानों में इससे संबंधित पाठ्यक्रमों में दाखिला लिया जा सकता है। एचबीटीआई, कानपुर में ऑयल ऐंड पेंट टेक्नोलॉजी में बीटेक कोर्स उपलब्ध है। शैक्षणिक योग्यता फिजिक्स, केमिस्ट्री और मैथमेटिक्स से 12वीं होनी चाहिए। इंजीनियरिंग की प्रवेश परीक्षा फ्लियर कर इसमें दाखिला पाया जा सकता है। सीआईएस स्टडीज, लखनऊ में डिप्लोमा पाठ्यक्रम है। यहां दूरस्थ शिक्षा के तहत एकवर्षीय डिप्लोमा कोर्स कराया जाता है। डिप्लोमा कोर्सेज में दाखिले के लिए न्यूनतम हाईस्कूल पास, तो पीजी डिप्लोमा में दाखिले के लिए ग्रेजुएट होना जरूरी है। एडवॉंस प्रोग्राम में उन्हें दाखिला मिलता है, जो कम से कम तीन वर्षों से इस क्षेत्र में काम कर रहे हों।

मीके कहां-कहां

अगर आप रंगों की दुनिया में अपना भविष्य बनाना चाहते हैं, तो पेंट ऐंड कोटिंग टेक्नोलॉजी में बेहतरीन

मीके हैं। देश ही नहीं, विदेशों तक में इस टेक्नोलॉजी के माहिर लोगों की हमेशा डिमांड रहती है। बीटेक करने के बाद ऑटोमोबाइल सेक्टर में मीके मिलते मिल जाते हैं। इसके अलावा पेंट निर्माता कंपनियों में भी प्रोफेशनल्स की नियुक्ति होती है। इस क्षेत्र में कोर्स करने के बाद कई क्षेत्रों में जाया जा सकता है। क्वालिटी कंट्रोल, केमिकल राइंस, मेटेरियल मैनेजमेंट, पेट्रोकेमिकल एवं रिफाइनिंग के क्षेत्र में भी प्रोफेशनल्स राहें तलाश सकते हैं।

अनिल कुमार सिंह

डिमांड में हैं पेंट प्रोफेशनल्स



पेंट टेक्नोलॉजी से बीटेक कोर्स की तो अच्छी खासी डिमांड है। इस कोर्स को करने के बाद कैरियर के कई एवेंच्युअर खुल जाते हैं। एक्सपोर्टिंग के बाद तरक्की भी मिलती है

और वेतन भी बढ़ता जाता है।

प्रो. राकेश कुमार त्रिवेदी, विभागाध्यक्ष,
ऑयल ऐंड पेंट टेक्नोलॉजी,
एचबीटीआई, कानपुर

मुख्य संस्थान

- एचबीटीआई, कानपुर
www.hbti.ac.in
- केमो इन्फार्मेटिक्स ऑफ साइंस स्टडीज, लखनऊ
www.cisstudies.in
- जामिया हमदर्द, नई दिल्ली
www.jamiahamdard.edu
- इंस्टीट्यूट ऑफ केमिकल टेक्नोलॉजी, मुंबई
www.ictmumbai.edu.in

बेहद उपयोगी

पेंट महज डेकोरेशन का ही माध्यम नहीं है, बल्कि मेटल या अन्य सर्फेस की सुरक्षा के लिहाज से भी इस टेक्नोलॉजी की अहम जरूरत होती है। केमिकल प्रोसेसिंग, केमिकल कॉस्मेटिक जैसे चीजों किसी प्रोडक्ट को न केवल चमकमाता लुक देती हैं, बल्कि उसको लाइफ को भी बढ़ा देती हैं।



पेंट टेक्नोलॉजी

बनाएं कलरफुल करियर

विगत कुछ समय से भारतीय परिवारों की जीवनशैली में बहुत परिवर्तन आया है। बहुराष्ट्रीय कंपनियों, मॉल्स, रियल एस्टेट और ऑटोमोबाइल कंपनियों के माहौल ने उनकी पसंद-नापसंद को काफी हद तक बदल दिया है और यही कारण है कि अब लोग बंधी-बंधाई सोच से अलग कुछ नया सोचने लगे हैं। यह सोच रंगों को लेकर भी बहुत बदल गई है। अब लोग विभिन्न रंगों के प्रयोगों के प्रति काफी सजग हो गए हैं। इस सजगता ने पेंट उद्योग की चमक को भी बदलकर रख दिया है

■ सुपर आइडिया डेस्क

इस बदलाव ने जहां काफी कुछ बदला, वहीं पेंट उद्योग में करियर की संभावनाओं को भी पंख लगा दिए हैं। विदेशी कंपनियों के आने से इस क्षेत्र में रोजगार की संभावनाएं तेजी से बढ़ती जा रही हैं, इसलिए पेंट की तकनीक को एक पाठ्यक्रम का रूप दे दिया जा, जिसे पेंट टेक्नोलॉजी कहा जाता है। इस क्षेत्र में प्रशिक्षित युवाओं की देश ही नहीं, दुनिया में भी भारी मांग है।

सीआईएस स्टडीज लखनऊ के प्रोग्राम को-ऑर्डिनेटर सुनील कुमार कुरावाहा के अनुसार पेंट टेक्नोलॉजी के पाठ्यक्रमों को सामान्यतः तीन श्रेणियों में बांटा गया है। पहली श्रेणी आधार पाठ्यक्रम की है

जिसमें बेसिक साइंस पर आधारित शैक्षिक पाठ्यक्रम आते हैं। इन पाठ्यक्रमों का आधार रसायन विज्ञान की वे शाखाएं होती हैं जो सीधे-सीधे रसायनों के मूल से जुड़ती हैं।

दूसरी श्रेणी के पाठ्यक्रम सीधे-सीधे विभिन्न आधारभूत सामग्री और प्रक्रियाओं के परीक्षण से जुड़े हुए होते हैं। इन पाठ्यक्रमों में प्रशिक्षण की यह व्यवस्था पूरी तरह से कंप्यूटर आधारित होती है। इस तरह से इंजीनियरिंग और कंप्यूटर विषयों के अंतर्गत पेंट-निर्माण और प्रयोग आदि की विधाओं के परीक्षण संपन्न होते हैं।

तीसरी श्रेणी के पाठ्यक्रम इन तकनीकों से जुड़े हुए हैं, जो पेंट के प्रयोग को उजागर करते हैं। इसके अंतर्गत सतही पेंट टेक्नोलॉजी यानी सरफेस कोटिंग टेक्नोलॉजी के विभिन्न विषय आते हैं।



यहां से करें कोर्स

- यूनिवर्सिटी डिपार्टमेंट ऑफ केमिकल टेक्नोलॉजी, नाथलाल पारिख मार्ग, माटुंगा, मुंबई।
- सी आई एस स्टडीज लखनऊ (www.cisstudies.in)
- डिपार्टमेंट ऑफ केमिकल टेक्नोलॉजी, फैक्ट्री ऑफ इंजीनियरिंग एंड टेक्नोलॉजी, कोलकाता यूनिवर्सिटी, कोलकाता।
- यूनिवर्सिटी डिपार्टमेंट ऑफ केमिकल टेक्नोलॉजी, नार्थ महाराष्ट्र यूनिवर्सिटी, डंबीनगर, जलगांव।

पेंट टेक्नोलॉजी में प्रशिक्षण दूरस्थ शिक्षा के माध्यम से सी आई एस स्टडीज में डिप्लोमा पाठ्यक्रम जैसे डिप्लोमा प्रोग्राम इन पेंट एण्ड कोटिंग टेक्नोलॉजी, पीजी प्रोग्राम इन पेंट एण्ड कोटिंग टेक्नोलॉजी और एडवांस प्रोग्राम इन पेंट एण्ड कोटिंग टेक्नोलॉजी है

चूंकि पेंट हर किसी की किसी न किसी रूप में आवश्यकता है, इसलिए इसका उत्पादन और उपयोगिता, दोनों ही असीमित हैं। यही कारण है कि इसमें हर स्तर पर रोजगार के अवसर हैं। आज देशी-विदेशी कितनी ही छोटी बड़ी पेंट निर्माता कंपनियां हैं। इन कंपनियों की साख यों ही नहीं है। इनमें कार्यरत कर्मचारी अपने क्षेत्र के महारथी होते हैं। जिस कंपनी में जितने ज्ञाता होते हैं, उसके उत्पाद की गुणवत्ता उतनी ही बेहतर होती है और उसी आधार पर उसकी मांग भी बढ़ती है।

यही कारण है कि एक पेंट कंपनी का अपना अनुसंधान एवं विकास विभाग होता है। यहीं पर पहले उत्पाद की कड़ी जांच की जाती है और जब वह कसीटी पर खरा उतरता है, तभी उसे बाजार में विक्रय के लिए उतारा जाता है। पेंट उद्योग तेजी से विस्तार पा रहा है। पेंट इंजीनियरों की मांग उनके उत्पादन से कहीं ज्यादा है। अगर आपमें काबिलियत है तो कोई भी पेंट कंपनी आपको हाथों-हाथ लेगी।

प्रशिक्षण के उपरांत आप प्रोडक्शन डिपार्टमेंट से लेकर रिसर्च, डिस्ट्रीब्यूशन, मैनुफैक्चरिंग आदि विभागों में जा सकते हैं। इसके अतिरिक्त उपभोक्ता डीलिंग, प्रिंटिंग तथा टीचिंग में भी विकल्प खुले हुए हैं। पेंट उद्योग में बहुत आकर्षक वेतन प्रदान किया जाता है। यदि आप किसी फर्म से नहीं जुड़ना चाहते हैं तो स्वरोजगार के रूप में अपना स्वयं का व्यवसाय भी शुरू कर सकते हैं। ■

पेंट टेक्नोलॉजी के पाठ्यक्रम में पेंट टेक्नोलॉजी के विभिन्न पक्षों, जैसे कच्चा माल, फार्मूला तैयार करना, पेंट व भंडारण पर रिसर्च कार्य, पेंट्स का अध्ययन, पेंट लगाने तथा सूखने के सिद्धांत, गुणवत्ता नियंत्रण, प्रोडक्शन संबंधी कार्य तथा प्रोजेक्ट के रूप में डिजाइन, कारखानों में प्रशिक्षण व सेमिनार आदि को पेश किया जाता है।

पेंट टेक्नोलॉजी में चमकीला कैरियर बनाने के लिए उम्मीदवार को कम से कम बारहवीं उत्तीर्ण होना जरूरी है। वर्तमान में देश में पेंट टेक्नोलॉजी के कई पाठ्यक्रम उपलब्ध हैं। उम्मीदवार अपनी योग्यता के अनुसार कोई एक पाठ्यक्रम चुन सकता है।

पेंट टेक्नोलॉजी में बारहवीं और खातक, दोनों ही स्तर के पाठ्यक्रम उपलब्ध हैं। जहां तक ग्रेजुएट स्तर के पाठ्यक्रम का सवाल है, इनमें बी.टेक इन पेंट टेक्नोलॉजी, बीएससी (टेक) पेंट्स, बी.टेक.इन केमिकल टेक्नोलॉजी, बी.टेक.इन ऑयल एंड पेंट टेक्नोलॉजी जैसे प्रमुख पाठ्यक्रम हैं



APPLY ONLINE

<https://cisstudies.in/apply-online.php>



INDUSTRIAL INSTITUTE

Best in class for all your needs

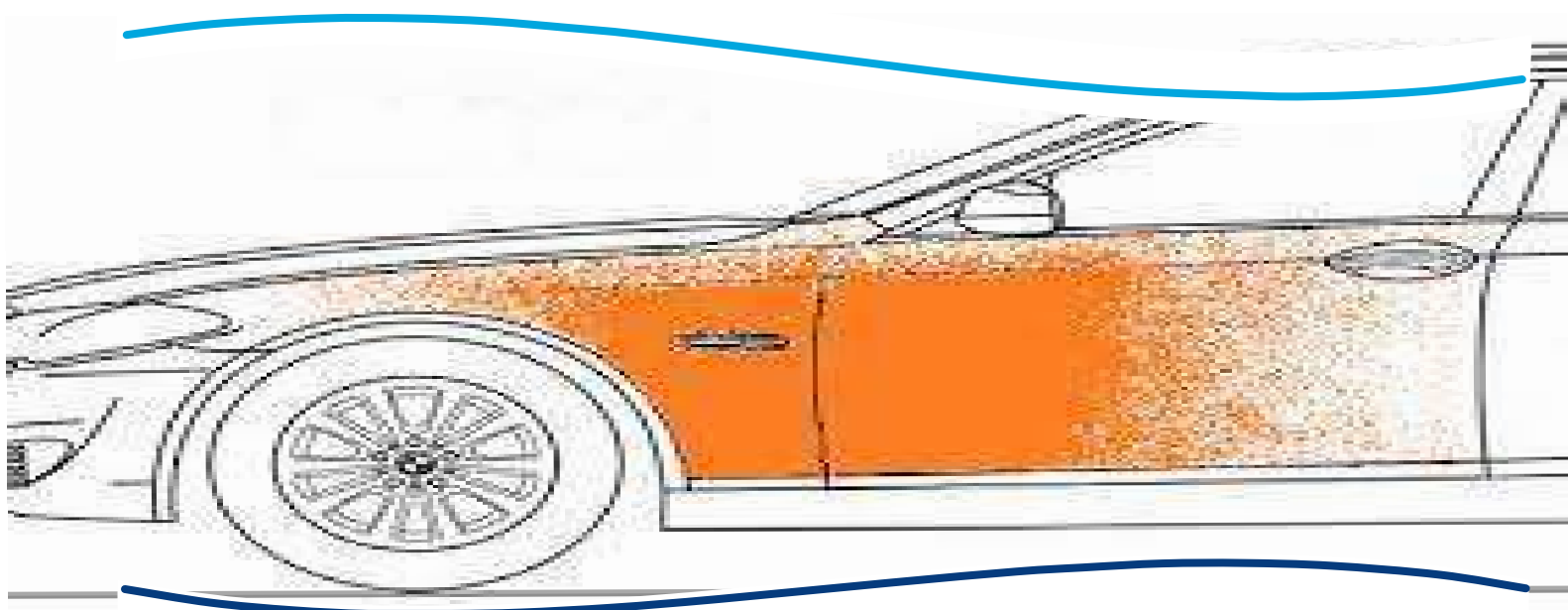

Cheminformatic Institute of Science Studies Lucknow

(Undertaking "Shivi Professional Academy opc P. Ltd.)
Regd by Government of India, Ministry of Corporate Affairs

Institute Address: SF-5, LDA Commercial Complex, Vibhav Khand- 4, Gomti Nagar, Lucknow-226010 (UP) INDIA
|T| 0522 3590661 |M| +91 9554 064 000 , +91 9559 196 700,

Visit: www.cisstudies.in

Email: info@cisstudies.in

 /Cisstudieslucknow

 @Cisstudieslko

 95540640000

 /Cisstudieslko

 /Cisstudieslko